

# manual

wally milk



WALLY

# wally milk

Operating Manual V1.0 - 05/2021  
MAN.26.1

## Chapters

- |                                                 |         |
|-------------------------------------------------|---------|
| 1. General Warnings and Safety Specifications   | page 3  |
| 2. Definition of Available Models               | page 8  |
| 3. Installation                                 | page 10 |
| 4. Operation                                    | page 13 |
| 5. Maintenance and Periodic Cleaning Operations | page 15 |
| 6. De-commissioning and Demolition              | page 16 |
| 7. Software Programming Guide                   | page 18 |

# WALLY

La Marzocco S.r.l.

Via La Torre 14/H  
Località La Torre  
50038 Scarperia e San Piero  
(Firenze) - ITALIA

[www.lamarzocco.com](http://www.lamarzocco.com)  
[info@lamarzocco.com](mailto:info@lamarzocco.com)

T: +39 055 849 191  
F: +39 055 849 1990

Original instructions verified by the  
manufacturer



Scan QR Code to view the complete  
Software Programming Guide available on  
the techcenter website.

Printed on recycled paper.

certifications available:



## 1. General Warnings and Safety Specifications

### WARNING

This appliance is for professional use only and should be installed in locations where its use and maintenance is restricted to trained personnel. Children are forbidden to operate or play with the appliance.

### WARNING

The appliance must be placed in a horizontal position on a counter higher than 80 cm from the ground.

### WARNING

This appliance is not suitable for outdoor use. Jets of water should not be used to clean the machine, nor should it be placed where water jets are used.

### CAUTION

As already mentioned in the preceding notes, the manufacturer shall not be held responsible for damage to objects, animals and/or people whenever the machine has not been installed according to the instructions contained in this manual, and is not used to do what it was designed for (i.e. preparing coffee and hot drinks).

#### 1) Important safeguards

- The weighted sound pressure level of the machine is lower than 70dBA.
- Use, cleaning and maintenance of this appliance are realized by people (including children

more than 8 years of age) with reduced physical, sensory or mental capabilities, or lack of experience and knowledge, as long as they have been given supervision or instructions concerning the use of the appliance by a person responsible for their safety and if they understand dangers.

- Children should be supervised to ensure that they do not play with the appliance.
- Keep the appliance and its cord out of the reach of children less than 8 years of age.

2) This operating manual is an integral and essential part of the product and must be supplied to users. Users are asked to read the enclosed warnings and cautions carefully, as they provide valuable information concerning safety during installation, operation and maintenance. This manual must be kept in a safe place and be available for consultation to new and experienced users alike.

3) Ensure product's integrity by inspecting the packaging, making sure it presents no signs of damage which might have affected the enclosed machine.

4) Check the machine's integrity after having carefully removed the packaging.

**Note: In case of doubt, do not go on any further and contact your dealer or retailer immediately. They will send out specialized personnel authorized to perform service on the appliance.**

5) Packaging (boxes, plastic bags, foam parts and whatever else) must not be left around within easy reach of children, due to the potential danger it represents, nor be discarded in the environment.

6) Check to see that data on the rating plate corresponds to those of the main electrical supply which the machine will be hooked up to.

7) The equipment must be installed to comply with the applicable federal, state or local electrical and plumbing codes. The installation also must comply to the manufacturer's instructions, and must be performed by qualified and authorized personnel.

8) Incorrect installation may cause injury/damages to people, animals or objects, for which the manufacturer shall not be held responsible.

9) Safe electrical operation of this device will be achieved only when the connection to the power outlet has been completed correctly and in observance of all local,

national, and international electrical codes and safety regulations, and particularly by grounding the unit. Make sure grounding has been done properly as it represents a fundamental safety requirement. Ensure qualified personnel check such connection.

10) Furthermore, you must ensure that the capacity of the available electrical system is suitable for the maximum power consumption indicated on the appliance.

11) We do not recommend using adapters, multiple plugs and/or extension cords. If you cannot avoid using them, make sure that they are

exclusively of the kind which conforms to local, national, and international electrical codes and safety regulations, being careful not to exceed the power and current ratings indicated on such adapters and extension cords.

**12) This device must be used exclusively for the functions it has been designed and built for. Any other application is inappropriate and dangerous. The manufacturer shall not be held responsible for any damages caused by improper and/or irrational use.**

This appliance should not be installed in kitchens.

13) Using any electrical device requires that certain

fundamental rules be observed. In particular:

- do not touch the device with wet or humid hands and feet;
- do not use the device while having no shoes on your feet;
- do not use extension cords in bath or shower rooms;
- do not unplug the device from the power outlet by pulling on the power supply cable;
- do not expose the device to atmospheric agents (rain, sun, etc.);
- do not allow children or untrained people to use this device;
- do not clean the control panel with a wet cloth since it is not watertight.

**14)** Before carrying out any maintenance and/or cleaning operations, turn the main switch, which is located on the front left of the machine, to the “0” or “OFF” position, and disconnect the machine from the electrical network by unplugging the cord or by switching off the relative circuit breaker. For any cleaning operation, follow exclusively the instructions contained in this manual.

**15)** In case the machine is operating in a faulty manner or breaks down, disconnect it from the electrical network (as described in the preceding point) and close the water supply valve. Do not attempt to repair it. Contact

a qualified and authorized professional to perform any repair. Any repairs must be performed exclusively by the manufacturer or by an authorized centre using only original parts. Non compliance with the above could compromise the safe operation of the appliance.

**16)** You should plan to make use of an omnipolar connector during installation, as required by local, national, and international electrical codes and regulations.

**17)** In order to avoid dangerous overheating problems, it is recommended that the power supply cable be fully unfurled.

**18)** Do not obstruct air intake and exhaust grilles and, in particular, do not cover the cup warmer tray with cloths or other items.

**19)** The machine’s power supply cable must not be replaced by users. In case the power supply cable becomes damaged, shut off the machine and disconnect the machine from the electrical network by switching off the relative circuit breaker and close off the water supply; to replace the power supply cord, contact qualified professionals exclusively.

**20)** These instructions are also available in an alternative format on a website

<http://techcenter.lamarzocco.com>.

21) The machine should be placed on a flat counter and must be placed in settings with the following temperatures:

Minimum room temperature:  
5°C/41°F;

Maximum room temperature:  
32°C/89°F.

22) If the machine has been temporarily housed in settings with a room temperature of less 0°C/32°F, the machine must be placed in a warmer environment in order to gradually defrost the hydraulic system prior to use.

23) Steam pressure supply must be between 0.14 and 0.17 MPa.

24) This machine is designed only for preparing coffee and hot drinks.

#### 25) Common Dimensions, Weights, and Features

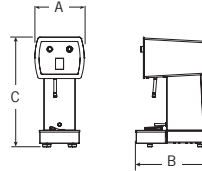

wally milk	
A [mm]	225
B [mm]	323
C [mm]	489
WEIGHT [kg]	10

## 2. Definition of Available Models

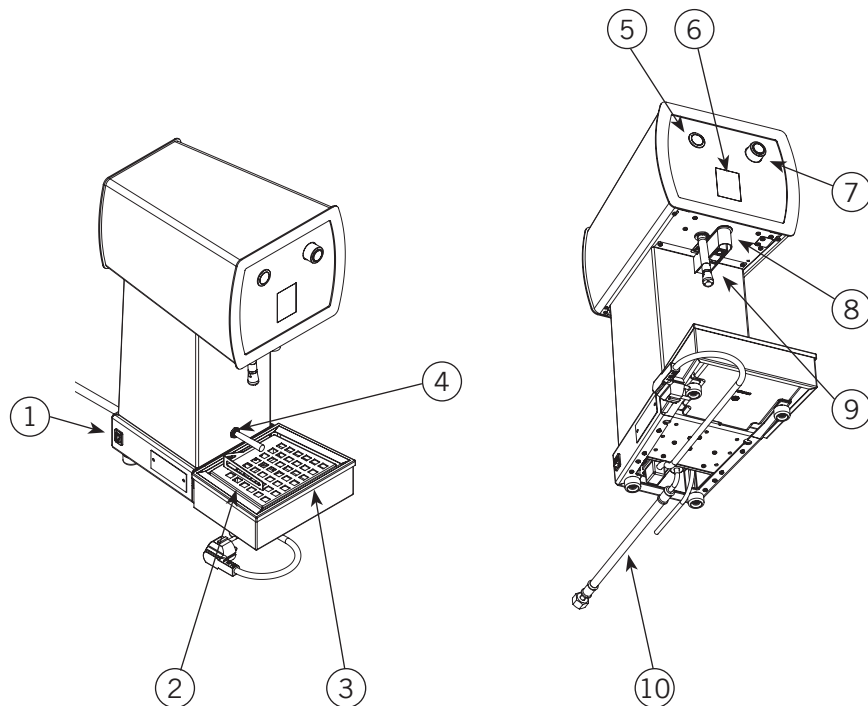

### Legend

- 1 Main Switch
- 2 Oscillating Platform
- 3 Removable Drain Tray
- 4 Temperature Sensor
- 5 Steam Button
- 6 Digital Display
- 7 Programming Encoder
- 8 Proximity Sensor
- 9 Steam Wand
- 10 Braided Hose for Steam

For additional information on electronics, keypads, and software programming, please see the section titled Software Programming your appliance.

**▲ WARNING ▲**  
Do not soil the lower area of the sensor when handling the wand.  
Failure to observe this warning may affect the operation of the appliance.

Fig. 1 - Model wally



## 1) General Description

The machine is available in a single version. To operate the machine, it must be connected to a steam source using the specific connection tube. Do not use tubes other than the one provided.

The main components that make up the machine are:

- Steam wand;
- Platform;
- Drip tray;
- Supply tube;
- Discharge duct.

## Remove machine from packaging

1) Ensure product's integrity by inspecting the packaging, making sure it presents no signs of damage which might have affected the enclosed machine.

2) Check the machine's integrity after having carefully removed the packaging. Packaging (boxes, plastic bags, foam parts and whatever else) must not be left within easy reach of children, due to the potential danger it represents, nor be discarded in the environment.

## 2) Description of the various parts

### • Steam wand

The steam wand is the component that allows the exit of the fluid. Do not touch the wand when the machine is operating.

Although equipped with “performance touch” technology, the wand could cause burns as a result of a contact.

To ensure proper functioning over time and always provide high-quality beverages, it is recommended to clean frequently the wand.

### • Platform

The platform is the area in which to place the pitcher. During the frothing operation, the platform will tilt to allow the foam to homogenise and obtain the best quality of the foam. Do not touch the pitcher or the platform during the frothing phase. The platform can be removed for cleaning.

### • Removable drain tray

When the machine is operating or during cleaning, there may be accidental spills of liquids. The drip tray allows containing liquids to avoid they get in contact with machine parts or that they end up on the counter. The drip tray can be removed to clean it in an easy manner.

### • Exterior cover

The exterior consists of painted and stainless sheet steel panels. To provide good aesthetics, to optimize ergonomics for the operator and to reduce the chance of damage to a minimum.

## • Machine CE plate:



## • Machine ETL plate:

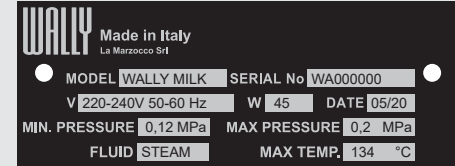

## • Machine KC plate:

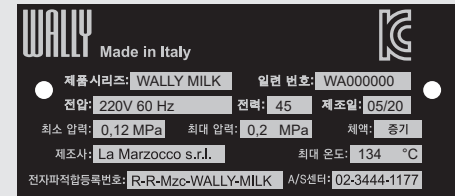

### 3. Installation

**▲ WARNING ▲**

At each installation, the appliance should be equipped with a new set of tubes for plumbing and related gaskets.

**▲ WARNING ▲**

Before making any electrical connections make sure that the two strain relief connectors are firmly secured to the body of the appliance in order to prevent inadvertent stress on the power cables.

**▲ WARNING ▲**

This appliance should not be installed in kitchens.

**▲ WARNING ▲**

The manufacturer declines any responsibility for any event leading to liability suits whenever grounding has not been completed according to current local, national, and international regulations and electrical codes, or other electrical parts have been connected improperly.

**▲ WARNING ▲**

Hazardous voltage disconnect from power supply before servicing.

**▲ WARNING ▲**

- U.S.A. and CANADA only - Do not connect to a circuit operating at more than 150V to ground on each leg.

**▲ WARNING ▲**

This appliance is not intended for use by persons (including children) with reduced physical, sensory or mental capabilities, or with lack of experience and knowledge, unless they have been given supervision or instruction concerning the use of the appliance by a person responsible for their safety.

**▲ WARNING ▲**

For the best result we recommend using the supplied Wally pitchers.

**WARNING**

In order to prevent cracks or leakage: do not store or install the appliance in places where in boiler or hydraulicsystem to freeze.

**WARNING**

This appliance is not suitable for outdoor use. Jets of water should not be used to clean the appliance, nor should it be placed where water jets are used.

**WARNING**

During the lifecycle of the machine, do not handle improperly the connection tube nor bring it near sharp objects or objects that can cause the breakage of the same. The breach of this requirement may cause damage to persons, animals or property.

**WARNING**

Ensure the correct connection of the supply tube. Improper installation can cause the malfunction of the machine and may damage persons, animals or property.

**WARNING**

It is recommended to replace the connection pipe every five years, even if the machine remains unused.

**WARNING**

Do not use a tube other than the one provided with the machine. The breach of this requirement may cause damage to persons, animals or property.

**Note:**

- The drinking water mains valve and the circuit breakers for the electrical system need to be located in the most convenient position for the operator to access them easily and quickly.
- This machine complies with the standard 61000-3-11.

### **1) Steam connection**

Connect the supply pipe of the steam source to the machine, ensuring the mechanical seal of the terminal fittings with thread 1/4" gas (BSP). If necessary, use the adapter 1/4"-1/8" gas (BSP). Ensure that the machine operates in a correct manner, it is recommended to use a source that supplies steam under pressure between 0.14 and 0.17 MPa (1.4 and 1.7 bar).

### **2) Electrical connections**

Connect the appliance to a power supply that is rated in accordance with the serial plate on the appliance.

### **3) Waste water drain connection**

The connection of the drain of the machine must be realized thanks to the plastic tube included in the supply. Connect one end of the plastic tube to the fitting of the drain pipe under the machine, by means of the quick connection. Connect the other end to a suitable drain water recovery system. If the above system is not available, and if acceptable according to the local rules, drain liquids can be collected in a suitable bucket and any extensions of the drain pipe shall use tubes in PVC and adequate tube fasteners.

## 4. Operation

### WARNING

The appliance must not be dipped in, nor splashed with, water in order to clean it. For cleaning operations, please follow the instructions listed below very carefully.

### WARNING

This appliance is designed only for preparing hot drinks.

### WARNING

To avoid the risk of injury, do not open the brew chamber during the brew process.

### WARNING

You can use pitchers other than those supplied, as long as their outer surface is painted.

### WARNING

During frothing, the platform will tilt. Do not interfere with the motion of the platform to prevent machine damage and improper milk frothing.

### WARNING

Maintain the temperature sensor in a good state of cleanliness. Dirt deposited on the sensor may compromise the operation of the machine.

### WARNING

Maintain the ultrasound distance sensor in a good state of cleanliness. Dirt deposited on the sensor may compromise the operation of the machine.

### 1) Turning the appliance on

Turn on power by pressing the main power switch. The main power switch may be found on the left rear of the machine.

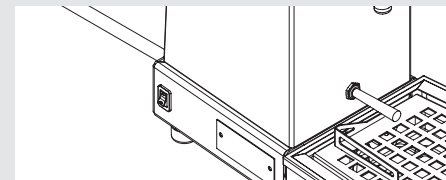

### 2) Pitcher

Fill the pitcher and place it on the platform, ensuring that the edge of the pitcher touches the walls positioned on the platform.

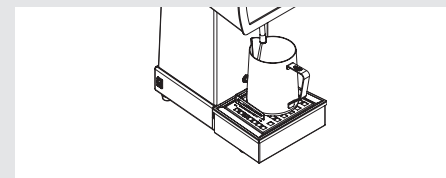

### 3) Select the desired program

Select the desired program by means of the encoder.

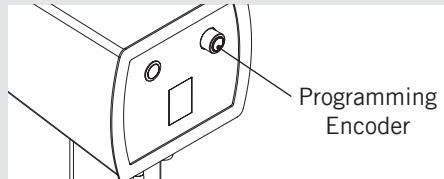

### 4) Steaming milk

Press the activation button and wait for milk frothing.

The delivery may not start if correct frothing parameters are not respected. Make sure the milk temperature in the pitcher is not greater than 25°C (77°F).

Also make sure that the pitcher contains an adequate level of milk. An excessive or insufficient amount can lead to improper operation of the machine. The temperature of the milk reaches almost 60/65°C (140/149°F).

Be careful not to allow liquid to overflow in order to avoid severe burns.

Once the milk is frothed and the wand has returned to the upper point, it is possible to drain. Press and hold the activation button for the desired time for wand drain. It is possible to drain once after each frothing.

## 5. Maintenance and Periodic Cleaning Operations

### WARNING

If the above-mentioned instructions are not adhered to the manufacturer cannot be held responsible for damage to persons or things.

### WARNING

In order to prevent cracks or leakage: do not store or install the appliance in places where temperature may cause water in boiler or hydraulic system to freeze.

### WARNING

Jets of water should not be used to clean the machine, nor should it be placed where water jets are used.

### WARNING

The appliance must be installed so that qualified technical personnel can easily access it for eventual maintenance.

### WARNING

The appliance must not be dipped in, nor splashed with, water in order to clean it. For cleaning operations, please follow the instructions listed below very carefully.

### WARNING

This appliance is for professional use only and should be installed in locations where its use and maintenance is restricted to trained personnel.

#### 1) Cleaning the drain collector

Remove the drain tray grill at least twice a week and clean, pull out the water drain collector and clean it thoroughly. Inspect and clean also the drain box and remove any leftover grounds.

#### 2) Cleaning the body

Wipe the stainless steel surfaces with a soft, non abrasive cloth in the direction of the glazing marks, if any. Do not use any alcohol or solvents whatsoever on painted or imprinted parts in order not to damage them.

#### 3) Cleaning the steam nozzles

Steam nozzles must be cleaned immediately after use with a damp cloth and by producing a short burst of steam so as to prevent the formation of deposits inside the nozzles themselves, which may alter the flavor of other drinks to be heated.

#### IMPORTANT

If the appliance has not been used for more than 8 hours or, in any case, after long periods of being idle, in order to use the appliance to its full potential it is necessary to perform some cleaning cycles before brewing beverages as follows:

- Being careful to avoid burns, turn on each steam wand for at least one minute.

If the appliance is not going to be used for long periods of time, it is advisable to follow these safety indications:

- Disconnect or interrupt the steam connection via a mains tap.
- Disconnect the appliance from the electrical mains.

## 6. De-commissioning and Demolition

### 1) De-commissioning and demolition

Start by setting the main switch to the “0” or OFF position.

#### Disconnecting from the power outlet

Disconnect the appliance from the electrical network by switching off the associated circuit breaker or circuit protection device. Remove the power supply cord from the power connection.

#### Disconnecting from the water system

Disconnect the steam pipe. Remove the reinforced plastic tubing on the drain connection.

At this point, the appliance may be removed from the bar, being very careful not to drop it or squash your fingers.

The appliance is made out of various materials and therefore, if you do not intend to put it back in service, it must be taken to a special disposal company which will select the materials which can be recycled and discard the others.

Current regulations make it illegal to discard such machine by leaving it on public grounds or on any private property.

#### Recycling notice: Warning for the protection of the environment.

Used Electrical and electronic waste contains hazardous but also valuable and scarce materials which should be recovered and recycled properly. We kindly ask that you contribute to the protection of the environment and natural resources by delivering used equipment to the relevant recycling locations if such locations are available in your country.









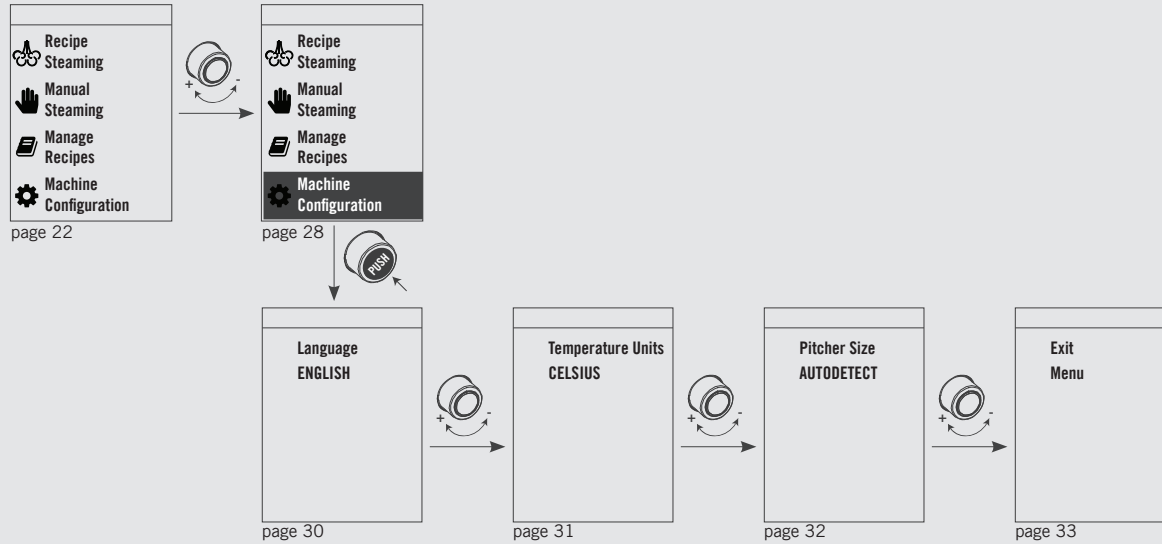

# 7. Software Programming Guide

# “Barista” Programming







## “Barista” Programming

# “Technical” Programming

 Recipe Steaming
 Manual Steaming
 Manage Recipes
 Machine Configuration

page 22



 Recipe Steaming
 Manual Steaming
 Manage Recipes
 Machine Configuration

page 28



Press and hold the Encoder Knob for 5 seconds.

Language ENGLISH
---------------------

page 34



Temperature Units CELSIUS
------------------------------

page 35



Full Access Mode ENABLED
-----------------------------

page 36



Pitcher Size AUTODETECT
----------------------------

page 37



# “Technical” Programming

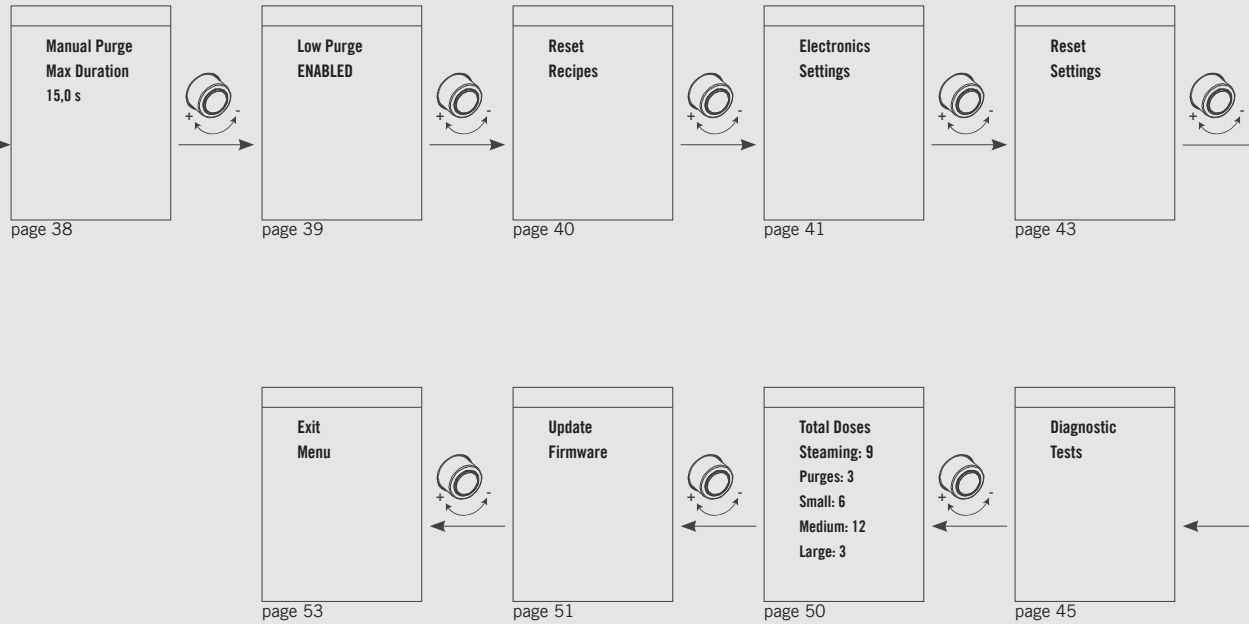

## Programming Display

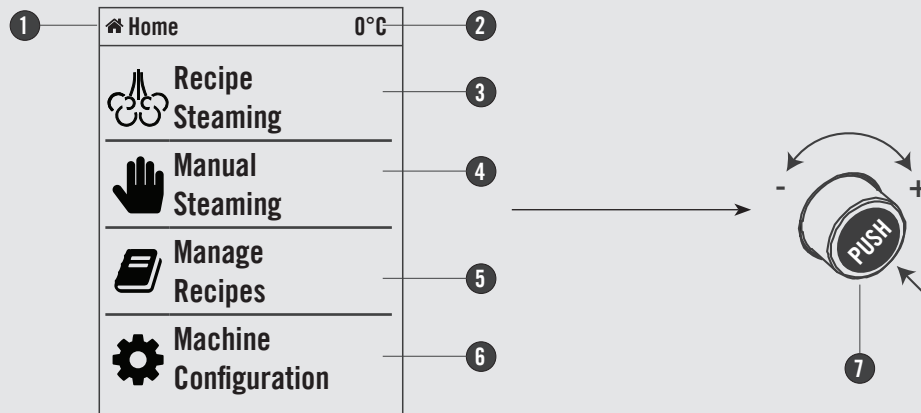

1 Graphic programming display with Encoder

2 Steam temperature

3 Steaming recipe list

4 Steaming in manual mode

5 Recipe management

6 Machine configuration (access the programming menu)

7 Encoder knob: Rotating to the right increases the value. Rotating to the left decreases the value. Pressing allows to browse the software menu, to access the functions or to confirm the first installation.

You can turn on/off the machine by pressing and holding the Encoder knob.

The display enables the operator to interact with the appliance to visibly change parameter values. The display also provides valuable information to the operator.

There are several warnings that can be displayed to alert the operator of an unusual condition or a fault. Additionally, simple messages are displayed alerting the operator that an action has been started or that a process needs to begin.

## Turning the Appliance On

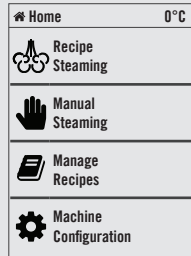





### Description

The following is the procedure for turning on the power to the appliance.

- Please follow the procedures carefully to avoid any damage to the appliance.

- Proceed checking for water connection to the appliance.

Display	Operating Procedure
<div data-bbox="175 707 307 883" style="border: 1px solid black; padding: 5px; margin-bottom: 10px;">Standby Mode</div> <div data-bbox="175 904 307 1079" style="border: 1px solid black; padding: 5px;"> <ul style="list-style-type: none"> <li> Recipe Steaming</li> <li> Manual Steaming</li> <li> Manage Recipes</li> <li> Machine Configuration</li> </ul> </div>	<div data-bbox="343 615 796 647" style="margin-bottom: 20px;"> <p><b>1</b> Turn the Main Switch to the 1 position.</p> </div> <div data-bbox="819 579 984 691" style="text-align: center;"> </div> <div data-bbox="343 780 718 812"> <p><b>2</b> The appliance is standby mode.</p> </div> <div data-bbox="381 976 944 1008" style="margin-top: 20px;"> <p>Press the Encoder Knob and the appliance is now on.</p> </div>

**WARNING**

**HAZARDOUS VOLTAGE DISCONNECT FROM POWER SUPPLY BEFORE SERVICING**

## Shut Down Procedures

### Turning the Appliance Off

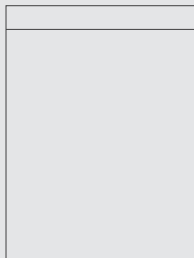

### Description

The following is the procedure for turning off power to the appliance.

- Please follow the procedures carefully to avoid any damage to the appliance.

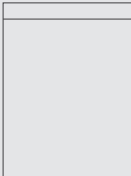
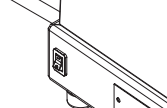
Display	Operating Procedure
	<p><b>1</b> Turn the Main Switch to the 0 position.</p>  <p><b>2</b> This is the OFF setting used in the normal operating conditions. During servicing or other conditions that warrant it, the main switch should be turned to the 0 position.</p> <p><b>3</b> The appliance is off and display should be blank. It is important to follow this procedure when turning off the machine. Failure to do so can damage the electronics.</p>



### WARNING



**HAZARDOUS VOLTAGE DISCONNECT FROM POWER  
SUPPLY BEFORE SERVICING**



## Recipe Steaming

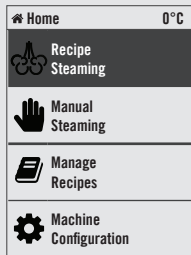

### Description

- This parameter allows the operator to view and choose all saved recipes.
- This parameter allows the operator to choose the preferred one from the saved recipes and to start it by pressing the start button.

Display	Operating Procedure
<p>A screenshot of the control panel menu. The top part is the same as the previous image, with 'Recipe Steaming' selected. Below this, there is a list of recipes: 'Cappuccino', 'Latte', and 'Flat White'. The 'Latte' option is highlighted with a dark background.</p>	<ol style="list-style-type: none"> <li>1 Press the Encoder Knob to access the “Recipe Steaming”.</li> <li>2 Turn the Encoder Knob to select the recipe, press the Encoder Knob to confirm the selection. Press the start button to start the selected recipe.</li> </ol>

# Manual Steaming

## Manual Steaming

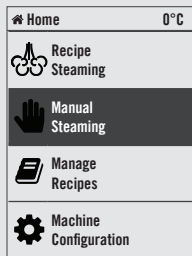

## Description

- This parameter allows the operator to dispense manually.
- This parameter allows the operator to choose from various options, such as Stretching (foam amount of the beverage) and temperature.

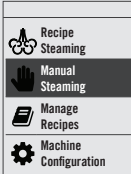
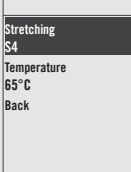
Display	Operating Procedure
 	<ol style="list-style-type: none"><li data-bbox="310 651 964 679">1 Press the Encoder Knob to access the “Manual Steaming”.</li><li data-bbox="310 835 1367 888">2 Turn the Encoder Knob to select the option, press the Encoder Knob to confirm the selection. Turn the Encoder Knob to change the value, press the Encoder Knob to confirm the desired value.</li></ol>

## Manage Recipes



### Description

- This parameter allows the operator to manage the recipes.
- This parameter allows the operator to choose from various options, such as moving, deleting, and editing the recipes.

Display	Operating Procedure
	<ol style="list-style-type: none"> <li>1 Press the Encoder Knob to access the “Manage Recipes”.</li> <li>2 Turn the Encoder Knob to select the option, press the Encoder Knob to enter the submenu.</li> </ol>

## Accessing Programming Mode

### Programming Mode

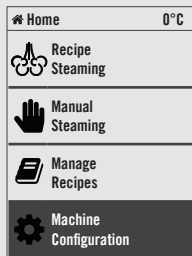

### Description

- To change the values of any parameter the operator must first enter into the programming mode.
- There are two levels within the programming mode that allow the programming of specific parameters.
- The two programming levels are as follows:
  - **Barista Programming** - The parameters contained within this level are ones the operator can change to affect the quality of the steam. No password is required for access.
  - **Technical Programming** - The parameters contained within this level are ones the operator can change to affect the performance of the appliance. These parameters are set in the factory and their adjustment requires the intervention of a service technician La

Display	Operating Procedure
	<p>Press the Encoder Knob to access the “Barista” programming menu.</p> <p><b>1</b> Press and hold the Encoder Knob. After about 5 seconds the “Technician” programming display will appear. (see point 3)</p> <p><b>2</b> This is the “Barista” programming level. To set the pitcher, to quality steam, and etc..</p>

## Programming Mode

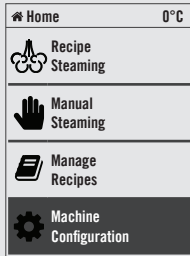

## Description

Marzocco recommends that no changes are made at this level. The Technician Password is required for access.

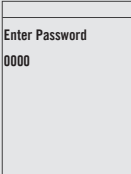
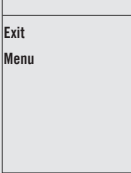
Display	Operating Procedure
 	<p><b>3</b> This is the “Technical” programming level. Using the Encoder Knob to move between the available parameters, press the Encoder Knob to confirm.</p> <p>This is the “Technical” programming level. To set the language, to quality steam, and etc..</p> <p><b>2</b> You must scroll to the exit menu to exit the programming mode, or press the Encoder Knob for 2 seconds.</p>

## “Barista” Programming

### Language



### Description

- This parameter allows the operator to change the language of the display.

Display	Operating Procedure
<p>A screenshot of the machine's LCD display showing the 'Machine Configuration' menu. The menu items are: 'Recipe Steaming', 'Manual Steaming', 'Manage Recipes', and 'Machine Configuration'. The 'Machine Configuration' item is highlighted. Below the menu, the word 'Language' is displayed, and 'ENGLISH' is shown in a larger font, indicating it is the selected option.</p>	<ol style="list-style-type: none"> <li>1 Press the Encoder Knob to access the “Barista” programming menu.</li> <li>2 Press the Encoder Knob to access the parameter, rotate the Encoder Knob to choose the desired language, press the Encoder Knob to confirm your choice.</li> </ol>

## Temperature Measurement Units

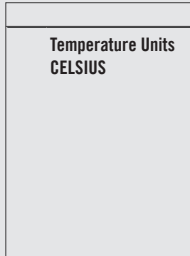

### Description

- This parameter allows the operator to change the temperature display from degrees Celsius to degrees Fahrenheit and vice versa.

Display	Operating Procedure
<p>A screenshot of the "Machine Configuration" menu. The menu items are: Recipe Steaming, Manual Steaming, Manage Recipes, and Machine Configuration (highlighted). Below the menu is a sub-menu for "Temperature Units" showing "CELSIUS".</p>	<ol style="list-style-type: none"> <li>1 Press the Encoder Knob to access the “Barista” programming menu.</li> <li>2 Press the Encoder Knob to access the menu, rotate the Encoder Knob to choose the desired option, press the Encoder Knob to confirm the option.</li> </ol>

## “Barista” Programming

### Pitcher Size



### Description

- This parameter allows the operator to adjust the settings of the pitcher.

Display	Operating Procedure
 A screenshot of a digital display showing a menu with four options: "Recipe Steaming" (with a steam icon), "Manual Steaming" (with a hand icon), "Manage Recipes" (with a document icon), and "Machine Configuration" (with a gear icon). The "Machine Configuration" option is highlighted with a dark background. Below the menu is another screenshot showing "Pitcher Size" followed by "AUTODETECT".	<ol style="list-style-type: none"><li>1 Press the Encoder Knob to access the “Barista” programming menu.</li><li>2 Press the Encoder Knob to enter the menu, rotate the Encoder Knob to choose between <b>FIXED</b> and <b>AUTODETECT</b>, press the Encoder Knob to confirm the option.</li></ol>



## Exit Menu

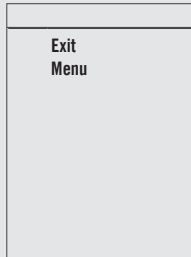

### Description

- This parameter allows the operator to exit the programming and return to the normal use of the appliance.

Display	Operating Procedure
	<ol style="list-style-type: none"> <li>1 Press the Encoder Knob to access the “Barista” programming menu.</li> <li>2 Press the Encoder Knob to exit the programming mode and return to the normal use of the appliance.</li> </ol>

## “Technical” Programming

### Language



### Description

- This parameter allows the technician to change the language of the display.

Display	Operating Procedure
<p>A screenshot of a control panel display showing a menu with four options: 'Recipe Steaming' (with a steam icon), 'Manual Steaming' (with a hand icon), 'Manage Recipes' (with a document icon), and 'Machine Configuration' (with a gear icon). The 'Machine Configuration' option is highlighted with a dark background. Below the menu, the word 'Language' is displayed in a bold font, and 'ENGLISH' is displayed in a smaller font below it.</p>	<ol style="list-style-type: none"> <li>1 After entering the password and accessing the “Technician” programming menu, rotate the Encoder Knob until the following is displayed.</li> <li>2 Press the Encoder Knob to access the parameter, rotate the Encoder Knob to choose the desired language, press the Encoder Knob to confirm your choice.</li> </ol>

**Temperature Measurement Units**

**Description**

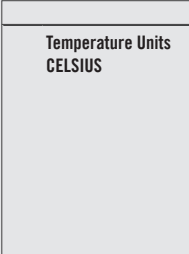

- This parameter allows the technician to change the temperature display from degrees Celsius to degrees Fahrenheit and vice versa.

Display	Operating Procedure
<p>A screenshot of a control panel display showing a menu with four options: "Recipe Steaming", "Manual Steaming", "Manage Recipes", and "Machine Configuration". The "Machine Configuration" option is highlighted. Below the menu, it says "Temperature Units" and "CELSIUS".</p>	<ol style="list-style-type: none"> <li>1 After entering the password and accessing the “Technician” programming menu, rotate the Encoder Knob until the following is displayed.</li> <li>2 Press the Encoder Knob to access the menu, rotate the Encoder Knob to choose the desired option, press the Encoder Knob to confirm the option.</li> </ol>

## “Technical” Programming

### Full Access

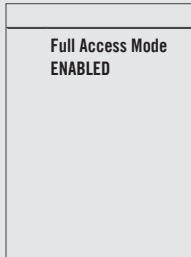

### Description

- This parameter allows the technician to enable or disable recipe management and editing.

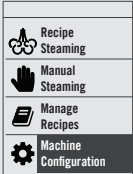
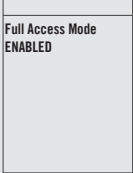
Display	Operating Procedure
 <p>The screenshot shows a menu with four options: "Recipe Steaming" (with a steam icon), "Manual Steaming" (with a hand icon), "Manage Recipes" (with a document icon), and "Machine Configuration" (with a gear icon). The "Machine Configuration" option is highlighted in a darker background.</p>  <p>The screenshot shows the text "Full Access Mode" followed by "ENABLED" on the next line.</p>	<ol style="list-style-type: none"> <li data-bbox="310 639 1498 693">1 After entering the password and accessing the “Technician” programming menu, rotate the Encoder Knob until the following is displayed.</li> <li data-bbox="310 831 1498 886">2 Press the Encoder Knob to access the menu, rotate the Encoder Knob to choose between <b>ENABLED</b> and <b>DISABLED</b>, press the Encoder Knob to confirm the option.</li> </ol>

**Pitcher Size**

**Description**



- This parameter allows the technician to adjust the settings of the pitcher.

Display	Operating Procedure
<p>A screenshot of a menu with four options: "Recipe Steaming" (with a glasses icon), "Manual Steaming" (with a hand icon), "Manage Recipes" (with a book icon), and "Machine Configuration" (with a gear icon). The "Machine Configuration" option is highlighted with a dark background. Below this menu is another screenshot showing "Pitcher Size" and "AUTODETECT".</p>	<ol style="list-style-type: none"> <li>1 After entering the password and accessing the “Technician” programming menu, rotate the Encoder Knob until the following is displayed.</li>   <li>2 Press the Encoder Knob to enter the menu, rotate the Encoder Knob to choose between <b>FIXED</b> and <b>AUTODETECT</b>, press the Encoder Knob to confirm the option.</li> </ol>

## “Technical” Programming

### Manual Purge

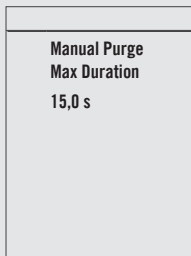

### Description

- This parameter allows the technician to set the time for the drain of the steam wand.

Display	Operating Procedure
<p>Recipe Steaming Manual Steaming Manage Recipes Machine Configuration</p> <p>Manual Purge Max Duration 15,0 s</p>	<ol style="list-style-type: none"> <li>1 After entering the password and accessing the “Technician” programming menu, rotate the Encoder Knob until the following is displayed.</li> <li>2 Press the Encoder Knob to access the menu. Turn the Encoder Knob to change the value, press the Encoder Knob to confirm the desired value.</li> </ol>

**Low Purge**

**Description**

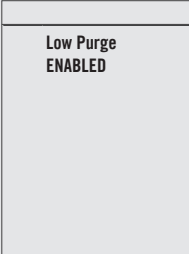

- This parameter allows the technician to choose whether to drain with the steam wand in low or high position.

Display	Operating Procedure
<p>A screenshot of a control panel display showing a menu with four options: "Recipe Steaming" (with a steam wand icon), "Manual Steaming" (with a hand icon), "Manage Recipes" (with a document icon), and "Machine Configuration" (with a gear icon). The "Machine Configuration" option is highlighted with a dark background. Below the menu, the text "Low Purge ENABLED" is displayed.</p>	<ol style="list-style-type: none"> <li>1 After entering the password and accessing the “Technician” programming menu, rotate the Encoder Knob until the following is displayed.</li> <li>2 Press the Encoder Knob to access the menu, rotate the Encoder Knob to choose between <b>ENABLED</b> and <b>DISABLED</b>, press the Encoder Knob to confirm the option.</li> </ol>

## “Technical” Programming

### Reset Recipes



### Description

- This parameter allows the technician to delete all the recipes saved.

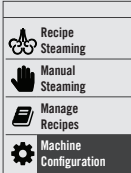
Display	Operating Procedure
 <p>The screenshot shows a vertical list of menu options: "Recipe Steaming" (with a steam icon), "Manual Steaming" (with a hand icon), "Manage Recipes" (with a document icon), and "Machine Configuration" (with a gear icon). The "Machine Configuration" option is highlighted with a dark background. Below this list is another screenshot showing the "Reset Recipes" option.</p>	<ol style="list-style-type: none"><li data-bbox="310 639 1498 693">1 After entering the password and accessing the “Technician” programming menu, rotate the Encoder Knob until the following is displayed.</li><li data-bbox="310 844 1498 874">2 Press the Encoder Knob to reset all the recipes saved.</li></ol>



**Electronics Board**

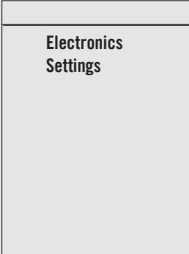

**Description**

- This parameter allows the technician to display the hardware and firmware version for all the electronic boards installed on the appliance.

Display	Operating Procedure
<p>A screenshot of a menu with four options: "Recipe Steaming" (with a steaming icon), "Manual Steaming" (with a hand icon), "Manage Recipes" (with a book icon), and "Machine Configuration" (with a gear icon). The "Machine Configuration" option is highlighted. Below this menu is a screenshot of the "Electronics Settings" menu.</p>	<ol style="list-style-type: none"> <li>1 After entering the password and accessing the “Technician” programming menu, rotate the Encoder Knob until the following is displayed.</li>   <li>2 Press the Encoder Knob to access the menu.</li> </ol>

## “Technical” Programming

### Electronics Board

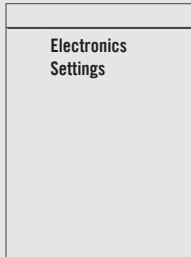

### Description

- This parameter allows the technician to display the hardware and firmware version for all the electronic boards installed on the appliance.

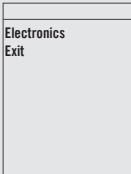
Display	Operating Procedure
 <p>Force FW Upgrade On Next Startup ENABLED</p>  <p>Electronics Exit</p>	<p><b>3</b> Press the Encoder Knob to access the menu, rotate the Encoder Knob to choose between <b>ENABLED</b> and <b>DISABLED</b>, press the Encoder Knob to confirm the option.</p> <p><b>4</b> Press the Encoder Knob to quit the submenu.</p>

**Reset**

**Description**



- This parameter allows the technician to reset all the values returning to initial factory settings.
- It is possible to reset the settings you made in the “Barista” programming or the settings you made in the “Technical” programming.

Display	Operating Procedure
<p>A screenshot of the machine's LCD display showing the 'Machine Configuration' menu. The menu items are: Recipe Steaming, Manual Steaming, Manage Recipes, and Machine Configuration. The 'Machine Configuration' item is highlighted with a dark background. Below this menu, a smaller screenshot shows the 'Reset Settings' screen.</p>	<ol style="list-style-type: none"> <li>1 After entering the password and accessing the “Technician” programming menu, rotate the Encoder Knob until the following is displayed.</li> <li>2 Press the Encoder Knob to access the menu.</li> </ol>



## “Technical” Programming

### Reset



### Description

- This parameter allows the technician to reset all the values returning to initial factory settings.
- It is possible to reset the settings you made in the “Barista” programming or the settings you made in the “Technical” programming.

Display	Operating Procedure
 A screenshot of a menu titled "Barista Settings Reset". The text "Barista Settings Reset" is centered in the menu.	<p><b>3</b> Press the Encoder Knob to reset the settings made in the “Barista” programming.</p>
 A screenshot of a menu titled "Technician Settings Reset". The text "Technician Settings Reset" is centered in the menu.	<p><b>4</b> Press the Encoder Knob to reset the settings made in the “Technician” programming.</p>

**Diagnostic Test**

**Description**

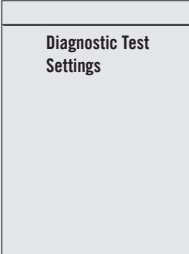

- This parameter allows the technician to verify the proper operation of the appliance.

Display	Operating Procedure
<p>A screenshot of a control panel menu. At the top, it says "Machine Configuration". Below this, there are four menu items: "Recipe Steaming" with a steam icon, "Manual Steaming" with a hand icon, "Manage Recipes" with a book icon, and "Machine Configuration" with a gear icon. The "Machine Configuration" item is highlighted with a dark background.</p> <p>Below the menu items, there is a section titled "Diagnostic Test Settings" which is currently empty.</p>	<ol style="list-style-type: none"> <li>1 After entering the password and accessing the “Technician” programming menu, rotate the Encoder Knob until the following is displayed.</li>   <li>2 Press the Encoder Knob to access the menu.</li> </ol>

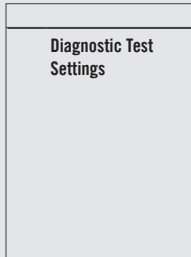

## “Technical” Programming

### Diagnostic Test

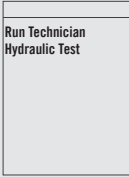

### Description

- This parameter allows the technician to verify the proper operation of the appliance.

Display	Operating Procedure
 A screenshot of a menu titled "Run Technician Hydraulic Test". The text is centered within a rectangular frame.	<p><b>3</b> Press the Encoder Knob to run the Hydraulic Test.</p>
 A screenshot of a menu titled "Platform Calibration". The text is centered within a rectangular frame.	<p><b>4</b> Press the Encoder Knob to run the Platform Calibration.</p>

**Diagnostic Test**

**Description**

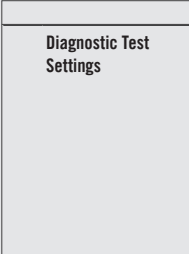

- This parameter allows the technician to verify the proper operation of the appliance.

Display	Operating Procedure
	<p><b>5</b> Press the Encoder Knob to enter the menu, rotate the Encoder Knob to set the desired value, press the Encoder Knob to confirm the value.</p>
	<p><b>6</b> Press the Encoder Knob to run the Set Default Emissivity.</p>

## “Technical” Programming

### Diagnostic Test

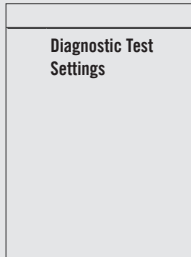

### Description

- This parameter allows the technician to verify the proper operation of the appliance.

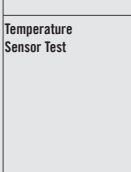
Display	Operating Procedure
	<p><b>7</b> Press the Encoder Knob to run the Set Custom Emissivity.</p>
	<p><b>8</b> Press the Encoder Knob to run the Temperature Sensor Test.</p>



## Diagnostic Test

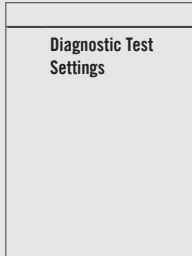

### Description

- This parameter allows the technician to verify the proper operation of the appliance.

Display	Operating Procedure
<p>A rectangular display area with a thin border. Inside, the text "Diagnostic Test Exit" is centered in a simple, sans-serif font.</p>	<p><b>9</b> Press the Encoder Knob to quit the submenu.</p>

# “Technical” Programming

## Dose Counter

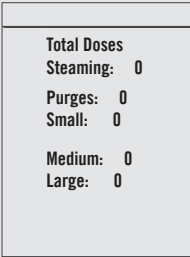

### Description

- This parameter allows the technician to review the total doses dispensed for each button.
- This parameter displays different values:
  - Total steaming doses;
  - Total purges doses;
  - Total small doses;
  - Total medium doses;
  - Total large doses.

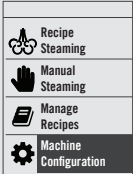
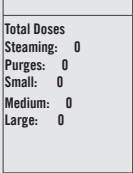
Display	Operating Procedure
 	<ol style="list-style-type: none"> <li data-bbox="310 639 1500 693">1 After entering the password and accessing the “Technician” programming menu, rotate the Encoder Knob until the following is displayed.</li> <li data-bbox="310 844 1500 874">2 You can display the total doses of each options.</li> </ol>

**Update Firmware**

**Description**



- This parameter allows the technician to update the control unit of the appliance via a USB Pendrive.

Display	Operating Procedure
<p>A screenshot of a control panel menu. It shows a vertical list of options: 'Recipe Steaming' (with a steam icon), 'Manual Steaming' (with a hand icon), 'Manage Recipes' (with a book icon), and 'Machine Configuration' (with a gear icon). The 'Machine Configuration' option is highlighted with a dark background. Below this list, there is a separate box containing the text 'Update Firmware'.</p>	<ol style="list-style-type: none"> <li>1 After entering the password and accessing the “Technician” programming menu, rotate the Encoder Knob until the following is displayed.</li>   <li>2 Press the Encoder Knob to access the menu.</li> </ol>

## “Technical” Programming

### Update Firmware



### Description

- This parameter allows the technician to update the control unit of the appliance via a USB Pendrive.

Display	Operating Procedure
	<p><b>3</b> Insert the USB Pendrive into the USB port and press the Encoder Knob.</p> <p><b>4</b> When the update is over, the appliance restarts. Set the switch to 0 (zero) and then again to 1.</p>

## Exit Menu

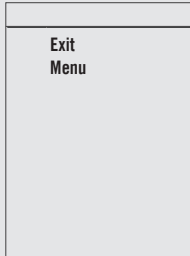

### Description

- This parameter allows the technician to exit the “Technical” programming and return to the normal use of the appliance.

Display	Operating Procedure
	<ol style="list-style-type: none"> <li data-bbox="348 639 1529 693">1 Press the Encoder Knob to exit the “Technician” programming mode and return to the normal use of the appliance.</li> </ol>

