

modbarTM
modular brewing systems

Operating Manual
Steam System

Contents

Warnings and General Guidelines	2
Product Handling and Transportation	3
Product Description	4
Power Switch Function	5
Startup Instructions	5
Installation	5
General Use.....	5
Operations and programming.....	6
Equipment Operation	6
Interface.....	6
Home screen	7
Main settings screen:.....	8
Preferences screen:	9
Advanced preferences screen:.....	10
File operations screen:.....	13
System info screen:.....	18
Dispensing Operations	19
Maintenance	20
General service/maintenance safety guidelines.....	20
Regular cleaning procedures	20
Cleaning the Steam Tips.....	20
Depressurize the Steam Boiler.....	20
Cleaning the exterior of the equipment	20
Water Filtration/Softener	20
Preventative maintenance.....	21
Basic diagnostics	22
Module not heating	22
Note on safety reset switches:.....	22
Tap not dispensing	22
Steam and/or water is visible around the ball fitting or drive shaft.....	22
Boiler not filling.....	22

Warnings and General Guidelines

- This machine is for professional use only, and should be installed in locations where its use and maintenance is restricted to trained personnel. Children are forbidden to operate or play with the machine.
- The equipment must be installed to comply with the applicable federal, state, or local electrical and plumbing code. The installation also must comply with the manufacturer's instructions, and must be performed by qualified and authorized personnel.
- Ensure that the specifications on the equipment name plate correspond to the main electrical supply to which you will connect the Modbar.
- Safe electrical operation of this device will be achieved only when the connection to the power outlet has been completed correctly and in observance of all local, national, and international electrical codes and safety regulations, and particularly by grounding the unit. Make sure grounding has been done properly as it represents a fundamental safety requirement. Ensure qualified personnel check such connection.
- Improper use or installation of Modbar equipment can cause product damage and or serious injury to end user. Modbar will not be held responsible for any damages or injuries occurring if equipment has been misused, installed improperly, or tampered with.
- When you receive your equipment, thoroughly inspect the packaging and equipment for any signs of damage. If damage is suspected, please contact Modbar support before attempting to install or operate the equipment.
- Modbar equipment is not intended for use outdoors or in an unconditioned environment where freezing temperatures may occur.
- Do not leave machine unattended during brewing processes.
- Do not use wet cloth to clean screens or switches on unit(s) as they are not waterproof.
- Repairs to Modbar equipment should be made only by trained technicians and use only Modbar approved parts.
- Incorrect installation may cause injury and/or damages to people, animals, or objects, for which the manufacturer shall not be held responsible.
- We do not recommend using adapters, multiple plugs and/or extension cords. If you cannot avoid using them, make sure that they are exclusively of the kind which conforms to local, national, and international electrical codes and safety regulations, being careful not to exceed the power and current ratings indicated on such adapters and extension cords.
- This device must be used exclusively for the functions which it has been designed and built for. Any other application is inappropriate and dangerous. The manufacturer shall not be responsible for any damages caused by improper and/or irrational use.

- Using any electrical device requires that certain fundamental rules be observed.
 - Do not touch the device with wet or humid hands and feet.
 - Do not use the device while having no shoes on your feet.
 - Do not use extension cords in bath or shower rooms.
 - Do not unplug the device from the power outlet by pulling on the power supply cable.
 - Do not expose the device to atmospheric agents (rain, sun, etc.).
 - Do not allow children or untrained people to use this device.
 - Do not clean the control panel with a wet cloth since it is not watertight.
- Before performing any maintenance and/or cleaning operations, turn the main power switch to the OFF position and disconnect the machine from the power source by unplugging the cord or by switching off the relative circuit breaker. For any cleaning operations, follow exclusively the instructions contained in the manual.
- If the equipment is operating in a faulty manner or breaks down, turn the main power switch to the off position, disconnect the machine from the power source (as described in the previous paragraph), and close the water supply valve. Do not attempt to repair it. Contact a qualified and authorized professional to perform any repair. Any repairs must be performed exclusively by the manufacturer or by an authorized technician using only original parts. Noncompliance with the above could compromise the safe operation of the equipment.
- Do not obstruct air intake and exhaust grilles.
- The machine's power supply cable must not be replaced by users. In the event that the power supply cable is damaged, shut off the equipment, disconnect the machine from the power supply by switching off the relative circuit breaker, and close the water supply valve. To replace the power supply cord, contact a qualified professional.

CAUTION – Risk of fire and electric shock. Replace only with manufacturer's cord set, part No. E-0118-01

ATTENTION - Risque d'incendie et de choc électrique . Remplacez-la uniquement avec le cordon de série du fabricant , partie n ° E-0118-01

Product Handling and Transportation

Modbar equipment is shipped in factory approved packaging. Upon receipt of equipment, thoroughly inspect the packaging for damage. If damage is suspected, contact Modbar immediately.

In the event that equipment needs to be returned to Modbar, or shipped for any reason, it should be shipped in the factory approved packaging. If you have discarded the packaging, please contact Modbar for replacements.

The equipment must be properly drained prior to shipment, to avoid damage from freezing. If you have questions about how to properly drain equipment for shipping, please contact Modbar support.

Do not store the equipment in places where temperature may cause water in the boilers to freeze.

Product Description

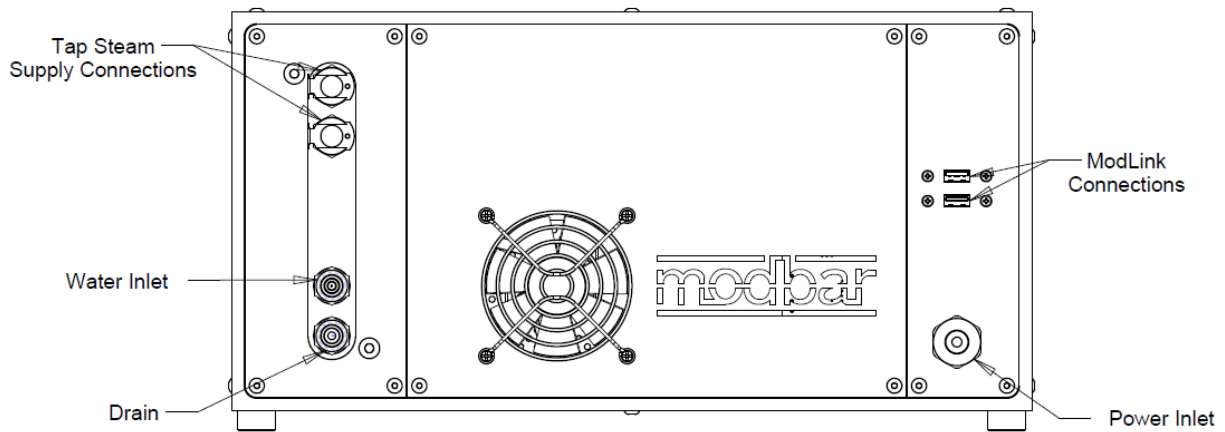
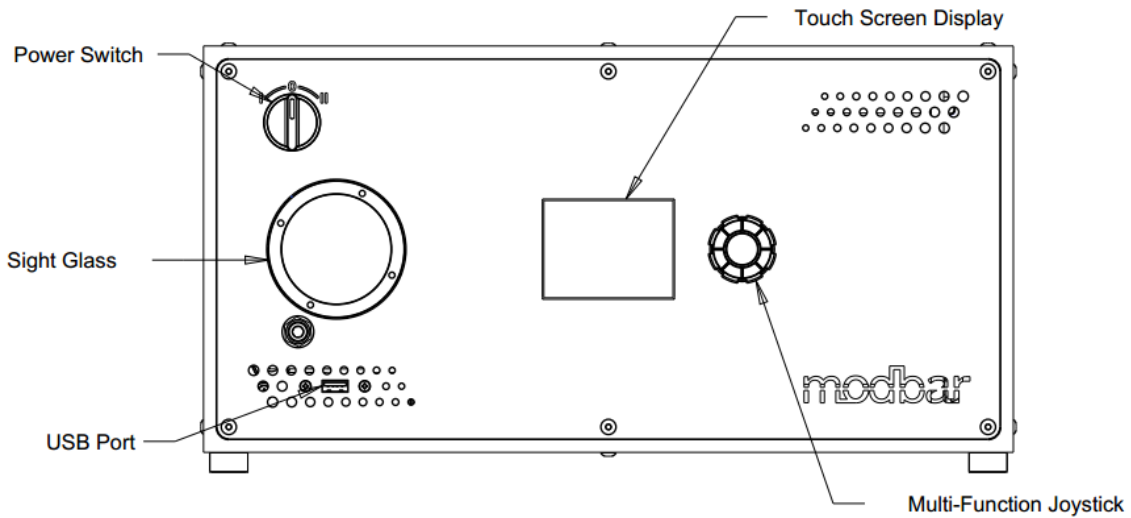

Power Switch Function

The three-position power switch on the Modbar module has three separate functions, as illustrated in the following image.

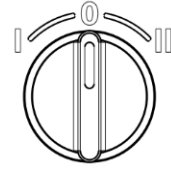

0 - Off

In this position, the module is in the off position.

I - Standby Mode

In this position, the module is in standby mode. When in standby mode, all operations function as normal, but no power is applied to the heating elements. This mode is used for priming the system upon installation, and can also be useful for some diagnostic applications.

II - Operating Mode

In this position, the module is in operating mode. Power is applied to the heating elements, and all functions operate as normal.

Startup Instructions

Installation

Upon installation, the Modbar steam module must be primed before use. This is accomplished by the following steps.

- Ensure that filtered water is supplied to the module.
- Ensure that the power switch is in the off position.
- Ensure that the module power cable is plugged into its appropriate power source.
- Turn the power switch counter-clockwise to place it in standby mode.
- The module will begin to fill the boiler. Once the maximum fill level is achieved, the module will cease to fill. When full, the sight glass will be approximately half full of water.
- At this point, it is safe to turn the switch clockwise into operating mode.

General Use

During general use, the module is already primed, and it is not necessary to prime the system. To start the module, follow these steps:

- Ensure that filtered water is supplied to the module.
- From the off position, turn the power switch clockwise to place it into operating mode.
- At this point, the elements will begin to heat. When each heat zone reaches set temperature, the module is ready for use.

Operations and programming

Equipment Operation

Interface

The touch screen is used for *selecting* and *displaying* data. The multi-function encoder is used for *editing* data. The functions of the encoder are shown below:

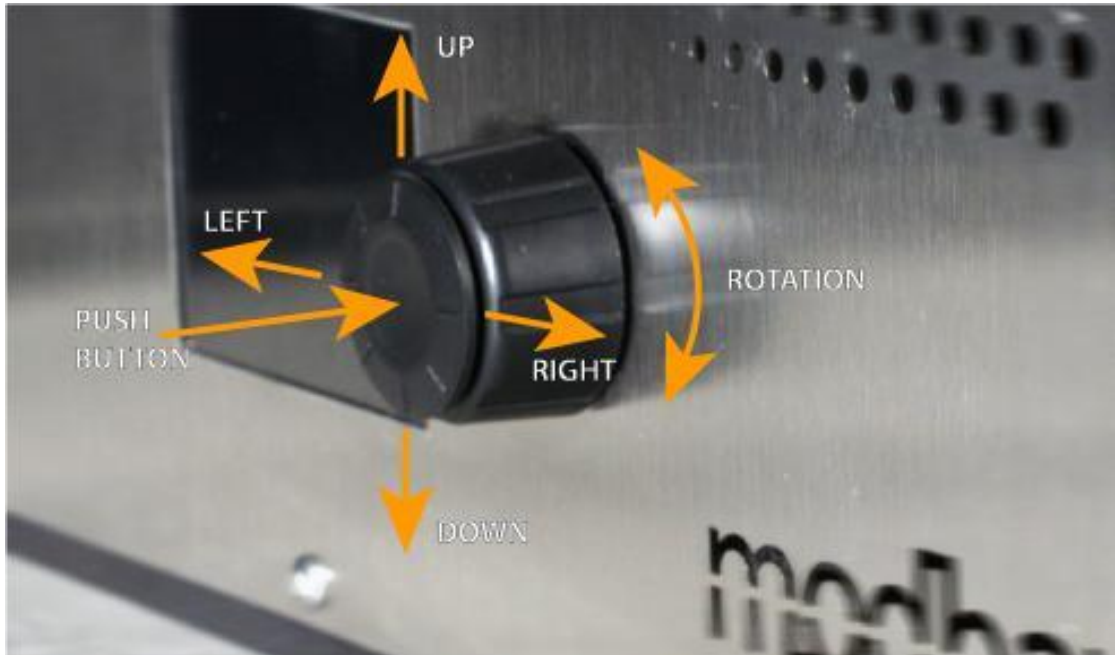

Home screen

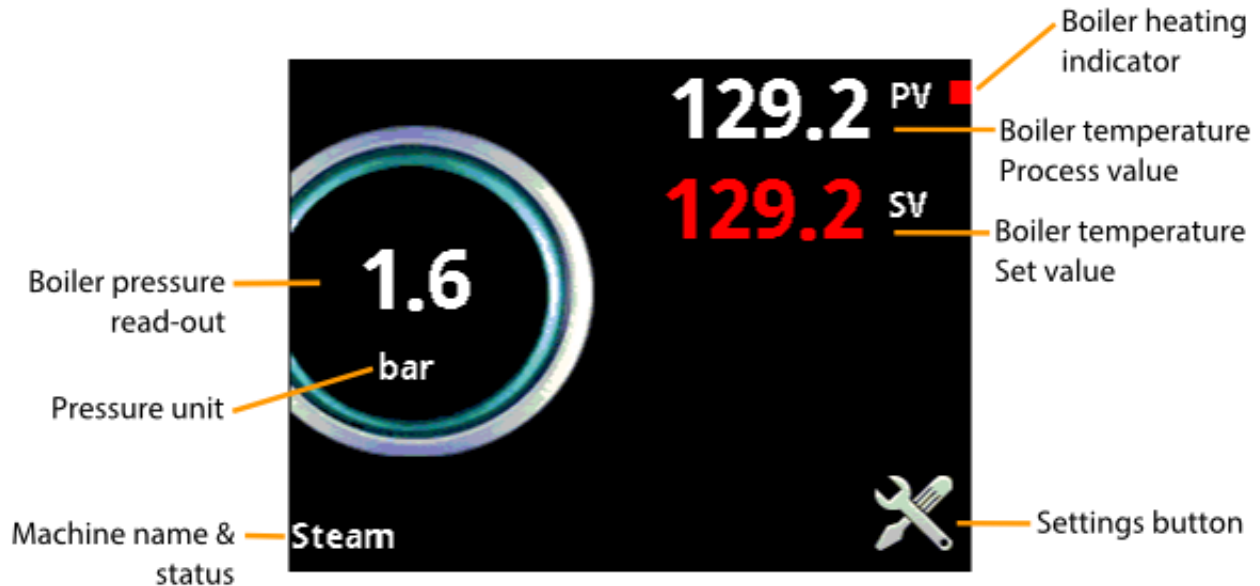

Boiler heating indicator: The red square indicates that the boiler is being commanded to heat. It is normal for this to flash on and off during regular operation.

Boiler temperature process value: This is the current value in degrees of the active heat zone (selected by the heat zone button).

Boiler temperature set value: This is the current set-point value in degrees for the active heat zone. To change the set temperature, simply touch the red value on the screen and the value will be highlighted. Rotate the encoder left or right to change the value in 1-degree increments. Press the joystick up or down to change the temperature in 1/10 degree increments. Press the center button on the joystick to save the change. The units for temperature are selected in the preferences/temperature unit's dialogue.

Settings button: This button navigates to the main settings screen.

Machine name & status: Displays the machine name and current status of the steam module.

Pressure unit: Displays the pressure units type (preferences/pressure units)

Boiler pressure read-out: Displays current pressure of the steam boiler, this pressure is relative and calculated by the boiler process temperature value. No boiler pressure will be present until the process temperature is above the boiler point of water (212°F / 100°C).

Main settings screen:

home -> main settings

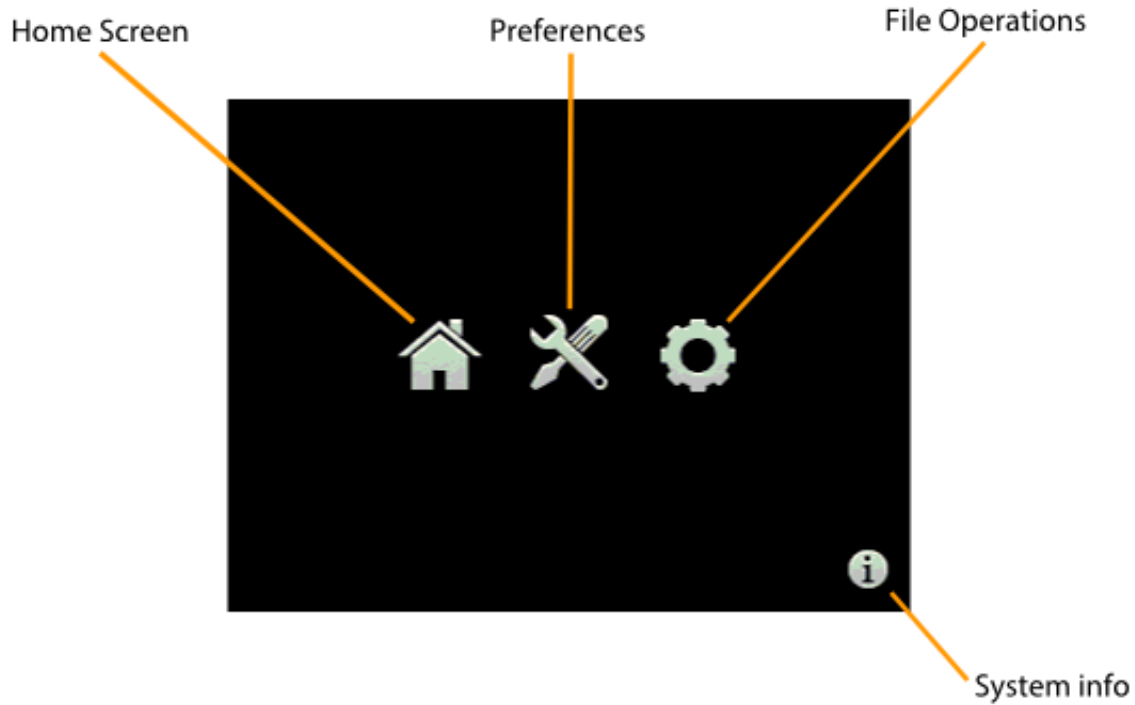

Home screen: This button navigates back to the home screen / dashboard.

Preferences: This button navigates to the system preferences page.

File operations: This button navigates to the file operations page.

System info: This button displays the system version and software information.

Preferences screen:

home -> main settings -> preferences

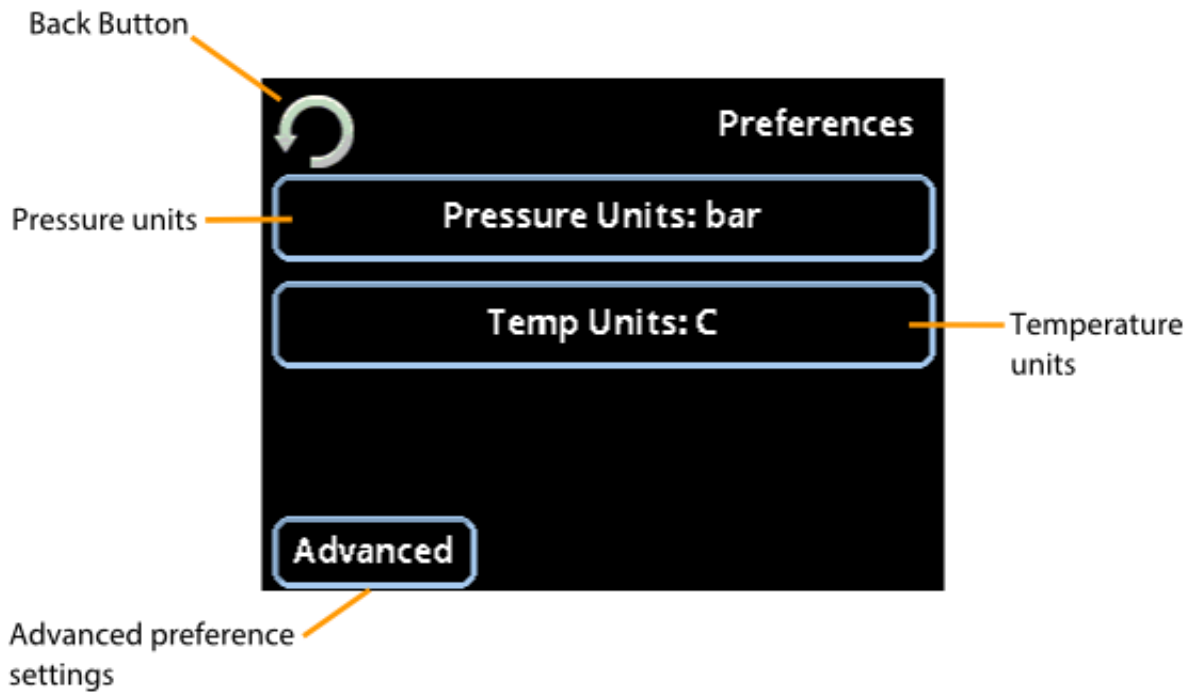

Pressure units: This button sets the system's pressure units, in: bars or psi

Temperature units: This button sets the system's temperature units, in: Celsius (C), Fahrenheit (F) or Kelvin (K)

Advanced: This button navigates to the advanced preference settings page.

Advanced preferences screen:

home -> main settings -> preferences -> advanced

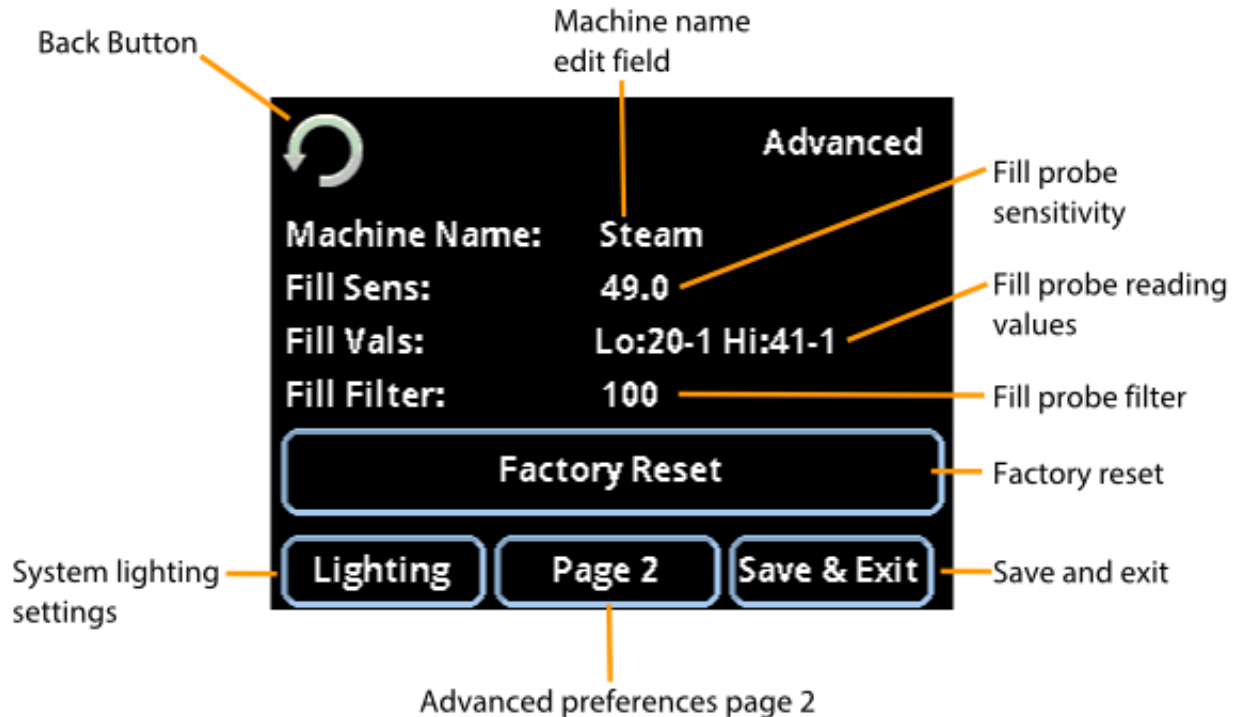

Machine name: This is a descriptive name for the module, touch the name to highlight the field, use the encoder wheel and push-button to rename the machine if desired.

Fill probe sensitivity: This setting is used to adjust the sensitivity of the fill level probe. Increasing the value will make the probe more sensitive, while decreasing the value will make the probe less sensitive. While it may be necessary to change the sensitivity value for water with very low tds levels, the need to adjust this setting is usually indicative of another issue, such as scale deposits on the probe or probe fitting. This setting should be used as a stopgap measure to maintain functional filling operation of the system until there is time to perform a detailed diagnosis and/or descaling procedure.

Fill probe reading values: This field displays the current reading from the fill probe, from 0-99% of its range of reading.

Fill probe filter: This setting is used to average a number of samples from the fill probe to avoid false readings. The setting shown is averaging 100 samples.

Factory reset: This will return all of the system settings to their original factory values. A confirmation screen is presented to confirm the operation of Factory Reset.

Lighting: This button navigates to the lighting settings screen.

Save & Exit: You guessed it! This button saves the settings changes and exits the current screen.

Advanced preferences screen page 2:

home -> main settings -> preferences -> advanced -> page 2



Fill button: In the event that the fill probe is not correctly causing the boiler to fill, this will allow you to manually fill the boiler until service can be performed to correct the problem. This button will fill the boiler while it is pressed and held. Release the button once the water fills approximately half of the sight glass.

Lighting screen:

home -> main settings -> preferences -> advanced -> lighting

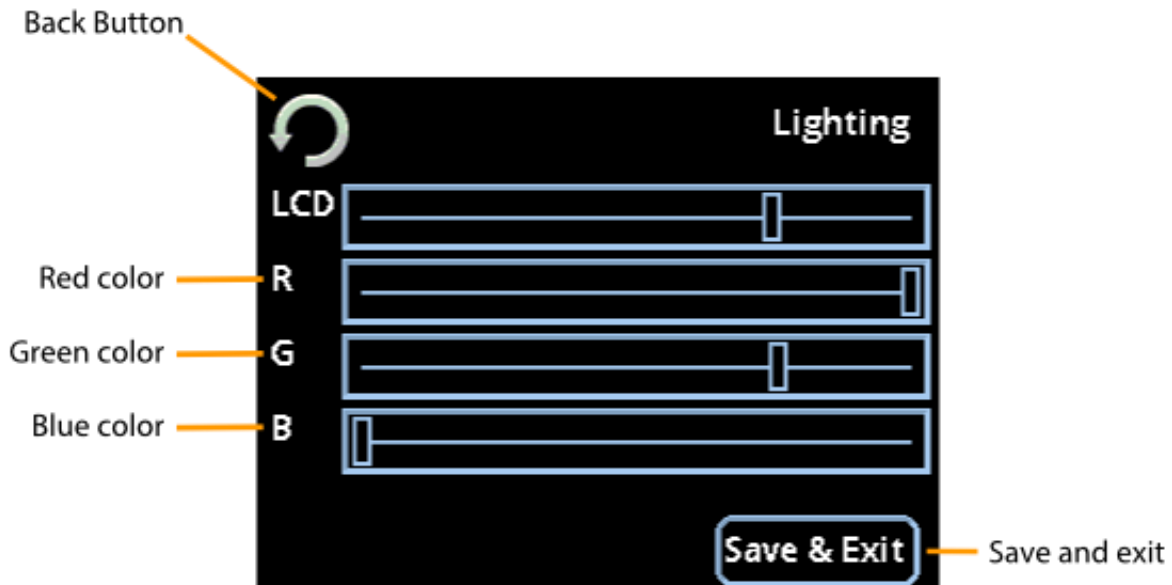

LCD backlight: Use this slider to control the brightness of the touch screen display.

RGB: Using the RGB color sliders you can create any color of the rainbow for the module's internal LED lighting.

File operations screen:

home -> main settings -> file operations

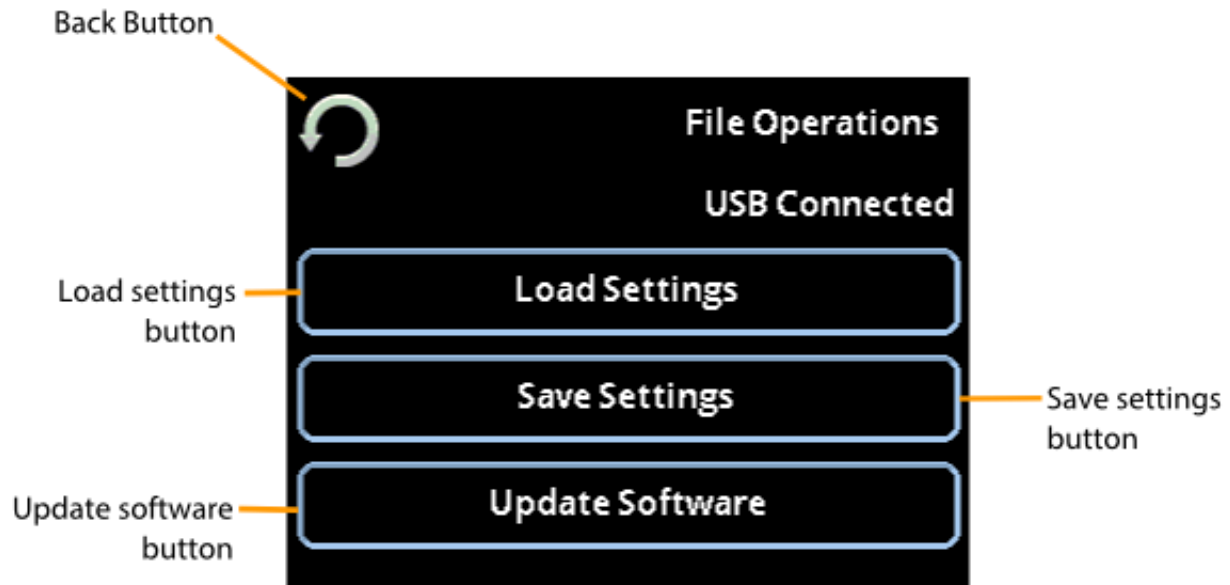

Load settings: This button will navigate to the load settings screen.

Save settings: This button will navigate to the save settings screen.

Update software: This button will navigate to the update software screen.

Load settings screen:

home -> main settings -> file operations -> load settings

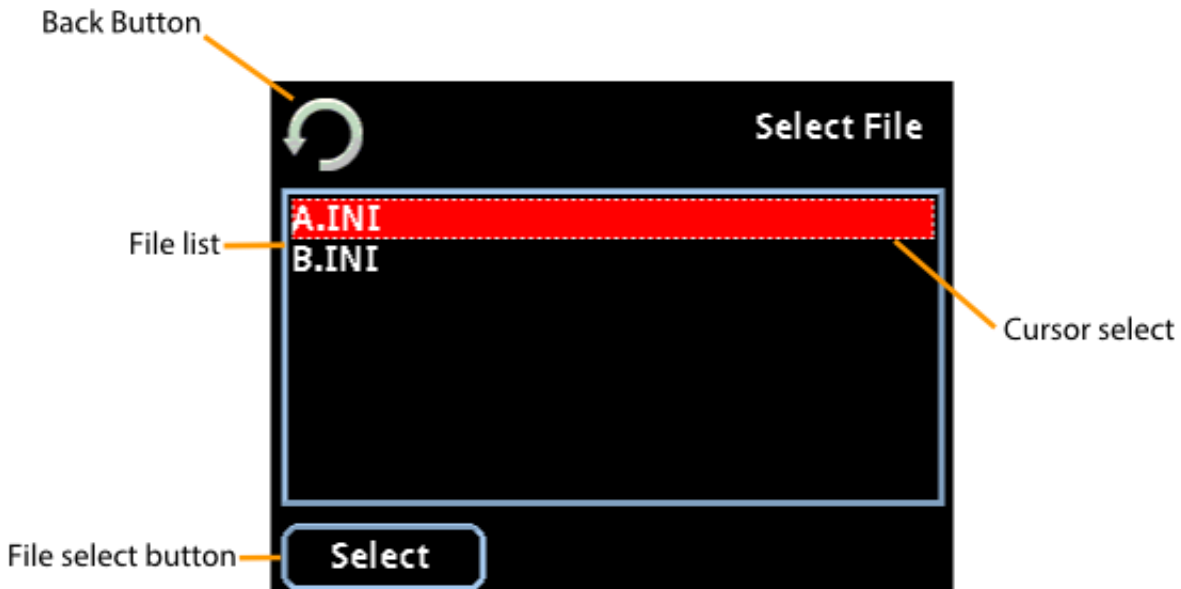

File list: This area displays all of the settings files that are currently saved to the USB drive.

Cursor select: The dotted outline cursor select indicates which file is selected on screen. You may use the rotary encoder or up/down function of the joystick to navigate the file list.

File select button: Pressing select will load the currently selected settings file. This all user accessible settings and preferences.

Save settings screen:

home -> main settings -> file operations -> save settings

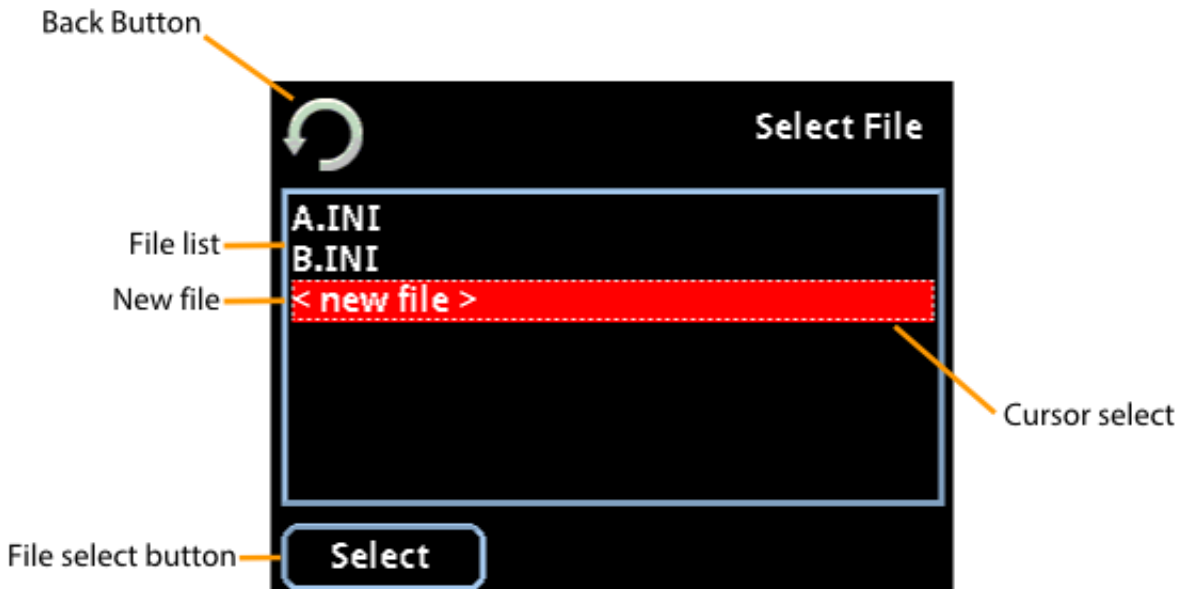

File list: This area displays all of the settings files that are currently saved to the USB drive.

New file: This option allows the creation of a new settings file. To create a new settings file, highlight the < new file > option, and select it by either pressing the center encoder button or the file select button on the touch screen.

Cursor select: The dotted outline cursor select indicates which file is selected on screen. You may use the rotary encoder or up/down function of the joystick to navigate the file list.

File select button: Pressing select will save the current settings to the selected file. This includes all user accessible settings and preferences.

New file screen:

home -> main settings -> file operations -> save settings -> new file



File name: This is a descriptive name for the settings file. Touch the name to highlight the field, use the encoder wheel and push-button to rename the file if desired.

Update software:

home -> main settings -> file operations -> update software

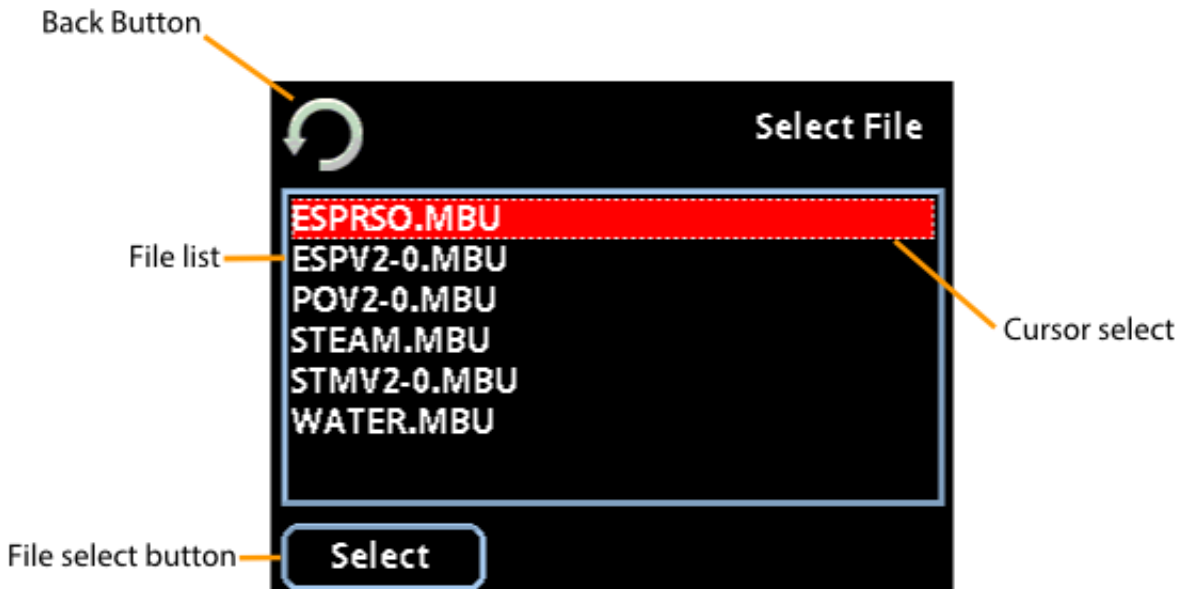

File list: This area displays all of the software update files that are currently saved to the USB drive.

Cursor select: The dotted outline cursor select indicates which file is selected on screen. You may use the rotary encoder or up/down function of the joystick to navigate the file list.

File select button: Pressing select will install the selected software update on the system. The software update process is complete when the machine reboots, displaying the Modbar logo on the module touch screen.

System info screen:

home -> main settings -> system info

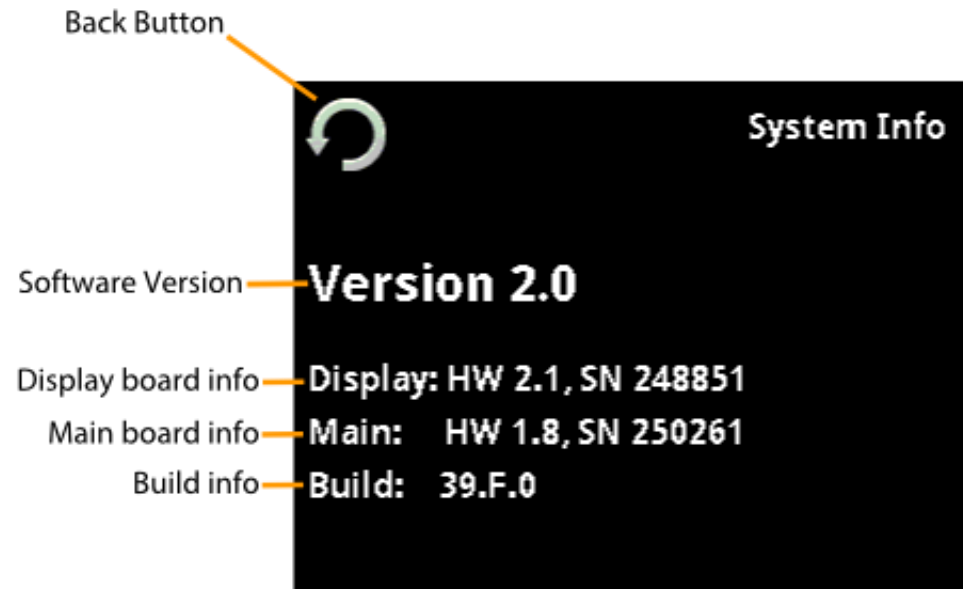

Software Version: This field displays the current software version loaded on the machine.

Display board info: This field displays the hardware version and serial number of the display board.

Main board info: This field displays the hardware version and serial number of the main board.

Build info: This field displays the software build of each of the circuit boards in the system.

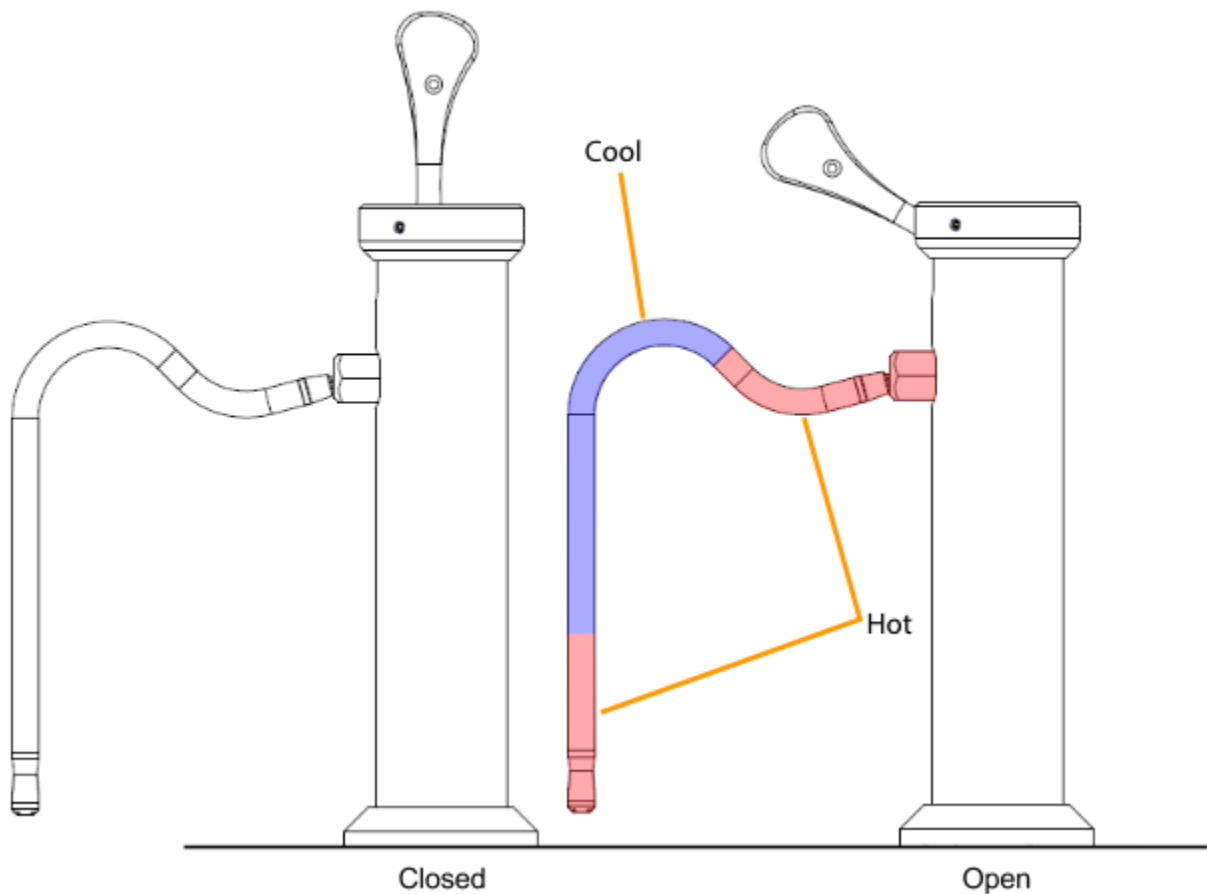

Dispensing Operations

The Modbar steam tap is operated via a lever handle located on top of the tap. This handle actuates a valve that allows steam to pass through the steam wand.

To dispense steam, move the lever handle from the closed position to the open position. If desired, steam velocity can be metered by moving the handle only slightly into the open position.

Note: Use caution when operating the steam tap. Steam is hot, and will burn you if it is used incorrectly. While we've taken every effort to ensure that the wand stays cool to the touch, the wand will become hot near the ends during normal use. We recommend only handling the wand near bent portion on top.

Maintenance

General service/maintenance safety guidelines

- Before performing any maintenance and/or cleaning operations, turn the main power switch to the OFF position and disconnect the machine from the power source by unplugging the cord or by switching off the relative circuit breaker. For any cleaning operations, follow exclusively the instructions contained in the manual.
- Always use care when performing maintenance, as the equipment may be hot. We recommend allowing the equipment to fully cool before performing any maintenance procedures.

Regular cleaning procedures

Regular cleaning procedures are important to both the longevity of the equipment and to the quality of the beverages which it produces. Following these procedures will help ensure long life and great tasting beverages.

Cleaning the Steam Tips

Steam nozzles need to be cleaned immediately after use with a damp cloth and by producing a short burst of steam to prevent residue from hardening on or inside the wands, which may affect the flavor and quality of drinks to be heated.

Depressurize the Steam Boiler

To depressurize the steam boiler for maintenance or transport, turn the main power switch to the OFF position. Pull down the steam tap lever(s) and allow to dispense until they cease to produce steam.

Cleaning the exterior of the equipment

The exterior of the taps and modules should be periodically cleaned. We recommend wiping the equipment with a damp microfiber cloth. Do not use cleaning solutions containing strong acids or caustic solutions. Take care not to use excessive liquid when cleaning around electronics, so as not to damage them.

Water Filtration/Softener

It is very important that the media for your water filtration is replaced on a regular basis, in accordance with the manufacturer's recommendations. Please refer to the documentation for your filtration system for proper operating and cleaning instructions.

Preventative maintenance

It is important that periodic maintenance be performed to keep your equipment in peak operating condition. Maintenance should be carried out by a qualified technician. Depending on usage, schedules may vary, but we recommend the following:

Every 3-4 Months

<ul style="list-style-type: none"> - Drain and refresh boiler water - Replace steam wand ball fitting o-rings - Replace steam wand valve drive shaft o-rings - Check water quality 	<ul style="list-style-type: none"> - Inspect water inlet solenoid valve - Inspect plumbing for leaks or clogs - Check all switches for proper operation - Inspect and clean fill probes
--	---

Every Year

<ul style="list-style-type: none"> - Inspect electrical wiring 	<ul style="list-style-type: none"> - Inspect boiler safety switches - Remove and clean/inspect boiler temperature probes
---	--

Every 3 Years

Check the interior of the boilers, and if necessary rinse out with a proper cleaning product / descaling solution allowed for food and beverage appliances

Water Quality

Water quality is very important to the proper function of your Modbar equipment. Improper water filtration can lead to serious problems with both your equipment and the quality of the coffee produced. At a minimum, the following water standards need to be met.

Total Dissolved Solids (All Equipment)	75-250 ppm
Total Hardness (Steam Only)	Less than 3 gpg
Total Hardness (Espresso and Pour-Over)	Less than 5 gpg
pH (All Equipment)	6.5-7.5

For more detailed information about water quality, please visit www.modbar.com/support.

Basic diagnostics

Module not heating

Verify that the power switch is turned clockwise to the operating mode position and not counter-clockwise to the standby mode position.

Note on safety reset switches:

The steam module features two safety reset thermostat controlled switches, attached near the heater port on the boiler. If the steam boiler does not heat it may be due to the activation of the safety reset switches, which are triggered by excess temperature and signify abnormal operation and possibly failed components. The safety switches mentioned are internal to the steam module and *are not* user-re-settable. If you believe a safety switch has been activated, the module may require service by an authorized technician. Please contact Modbar for additional support and information.

Tap not dispensing

Verify that there is water in the sight glass. If the boiler is over or under full, this will cause the tap to cease functioning.

Verify that pressure is adequate. If the temperature is programmed to below boiling, the tap will not function.

Verify that the tap handle is pressing the internal drive shaft located below it. If the handle is too loose, the tap will not function.

Steam and/or water is visible around the ball fitting or drive shaft

This indicates that the o-ring is beginning to wear, and that the machine will soon need preventative maintenance. Please contact Modbar Support for an o-ring kit, as well as detailed replacement instructions.

Boiler not filling

Verify that water is turned on to the module.

Verify that water pressure is adequate. The operable pressure range for Modbar equipment is 35-70psi. If water pressure is too low, the boiler will not fill.

Verify that the displayed machine status reads "Filling" on the home screen. If it does not, this more than likely indicates scale on the fill probe, and the probe will need to be cleaned and/or the boiler may need to be descaled. Contact Modbar support for cleaning and descaling instructions.